

1 8" FND. WALL @ GARAGE
SCALE: 1" = 1'-0"

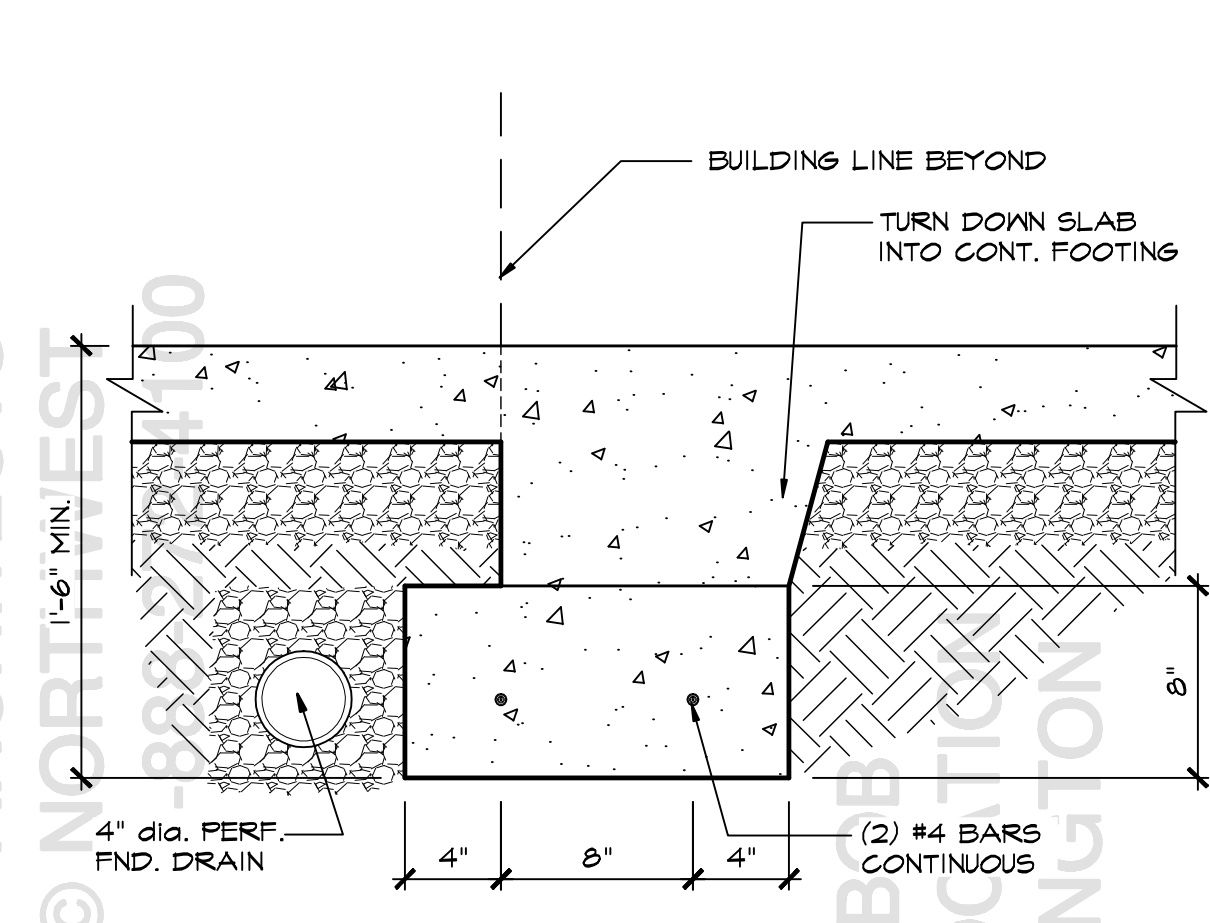

2 THICKENED SLAB @ O.H. DOOR
SCALE: 1 1/2" = 1'-0"

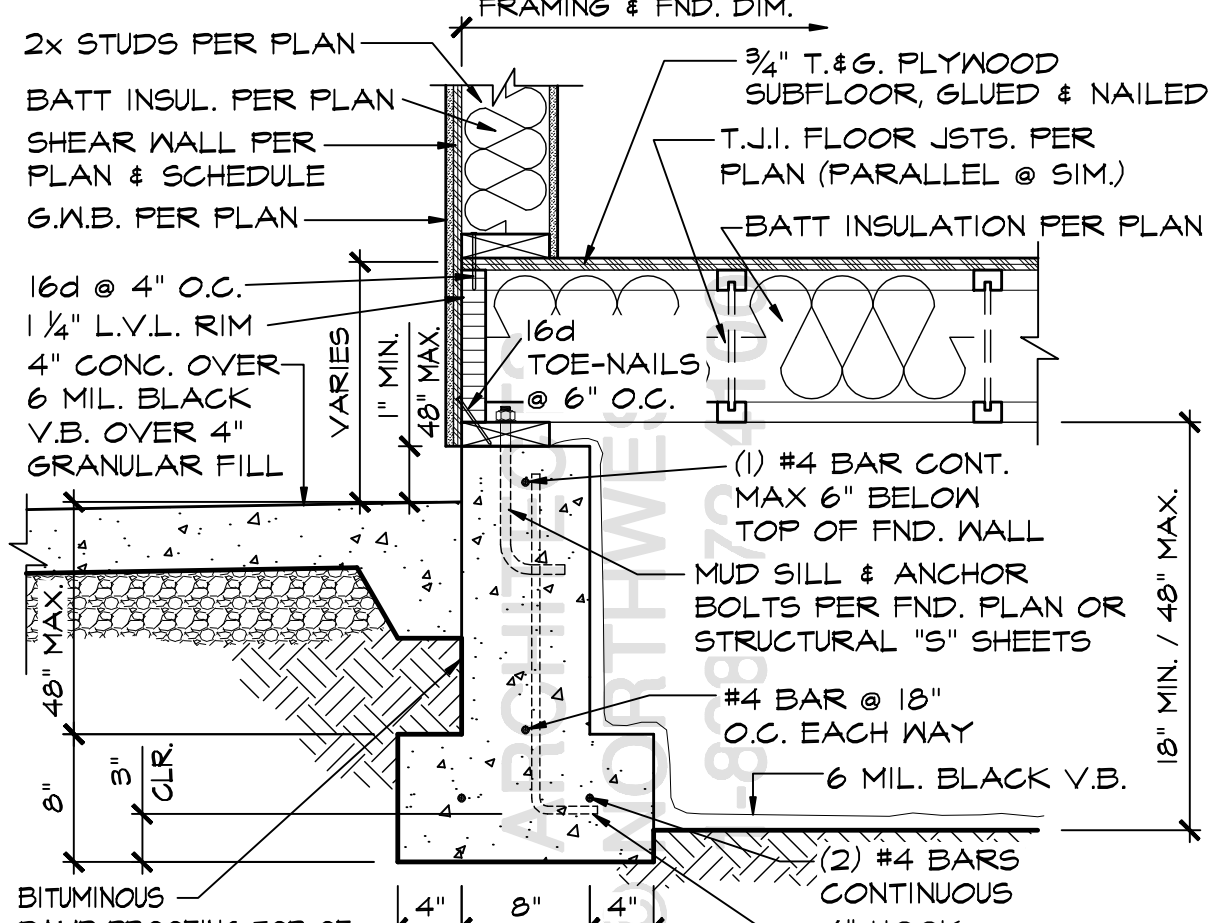

3 8" FND. WALL @ HOUSE/GARAGE
SCALE: 1" = 1'-0"

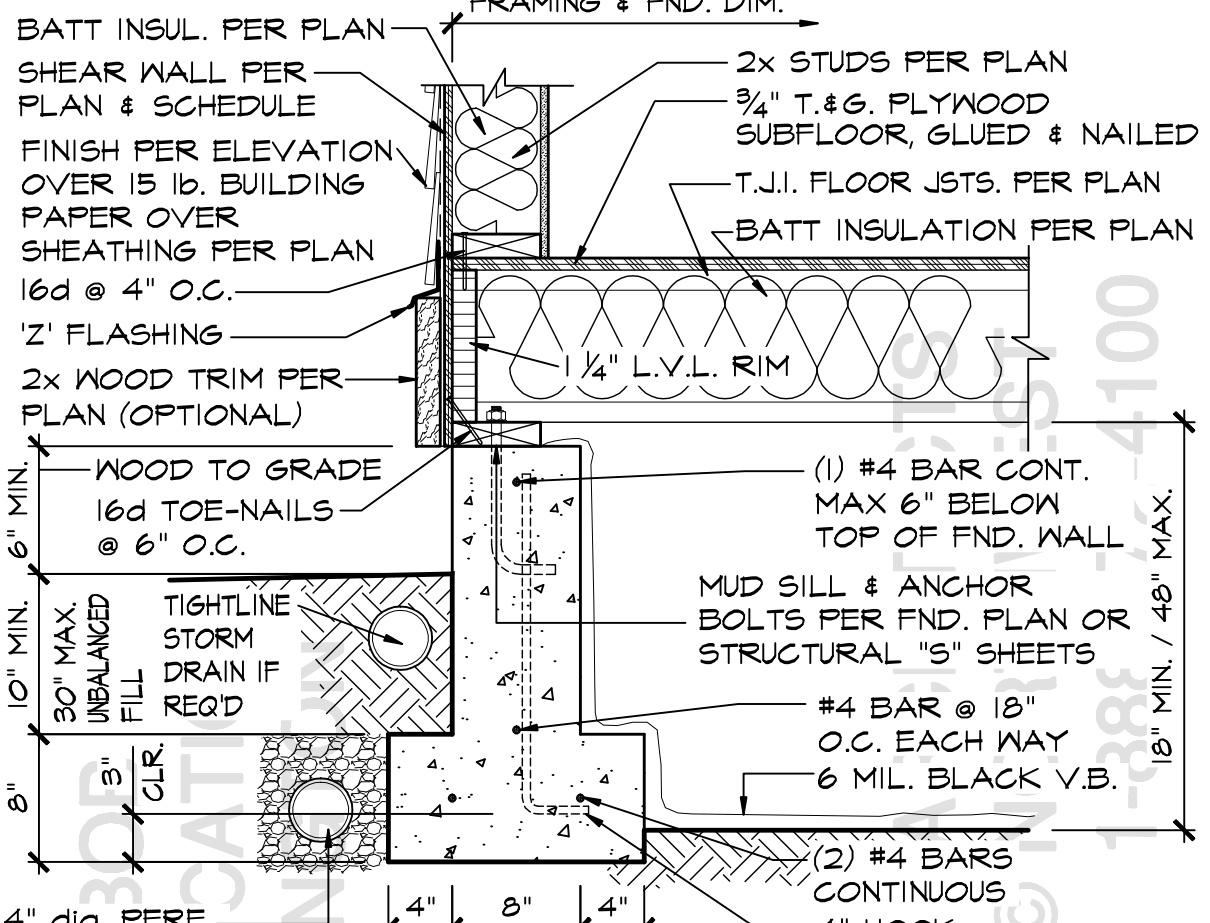

4 TYP. 8" FND. WALL
SCALE: 1" = 1'-0"

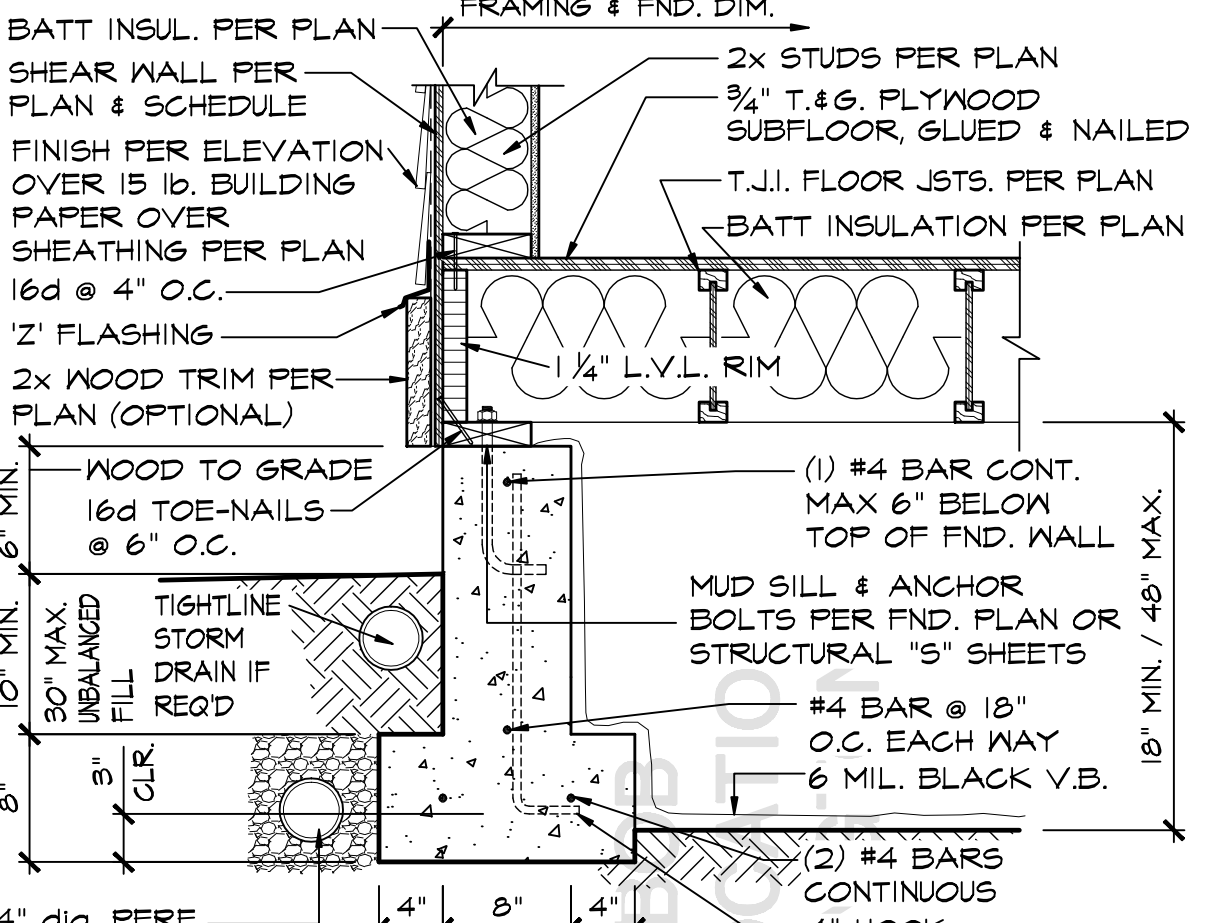

5 TYP. 8" FND. WALL
SCALE: 1" = 1'-0"

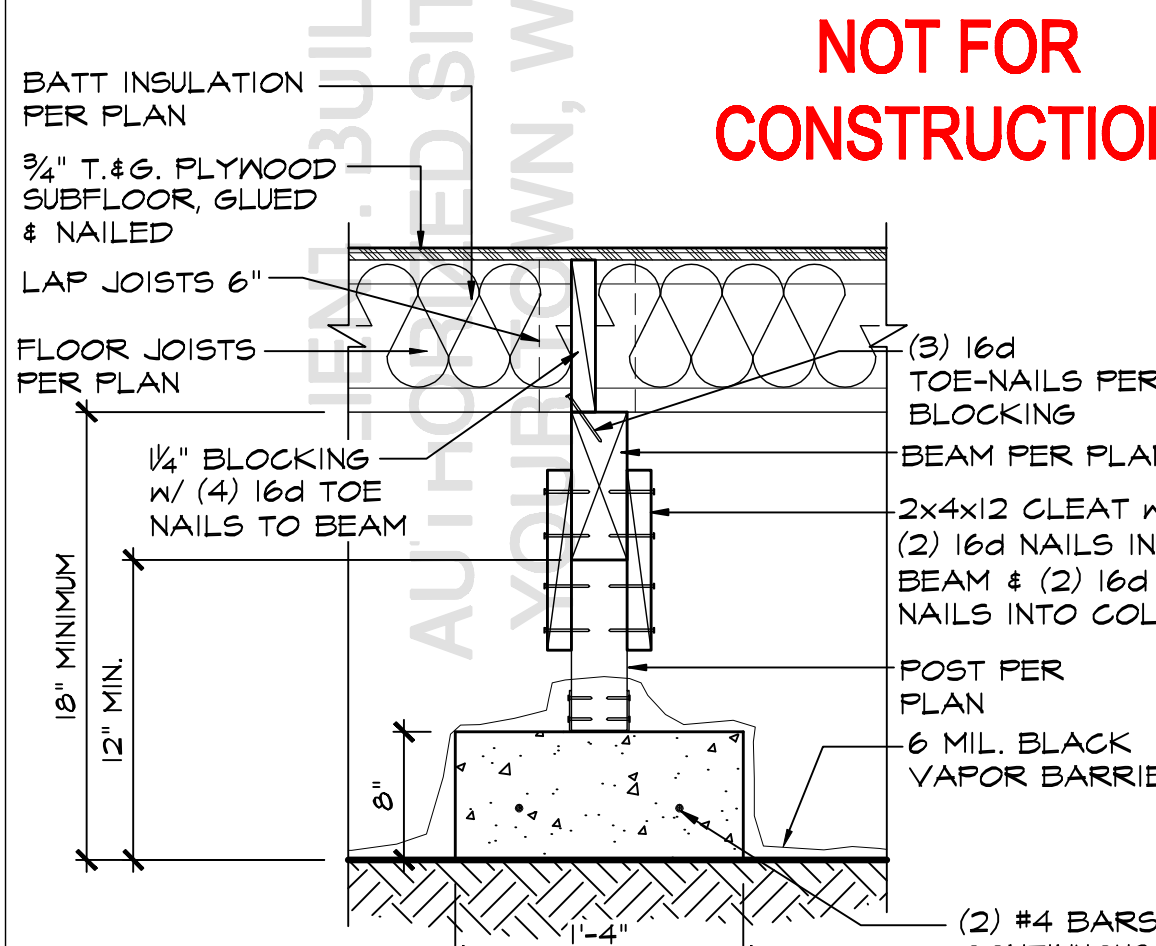

6 CONTINUOUS FOOTING
SCALE: 1" = 1'-0"

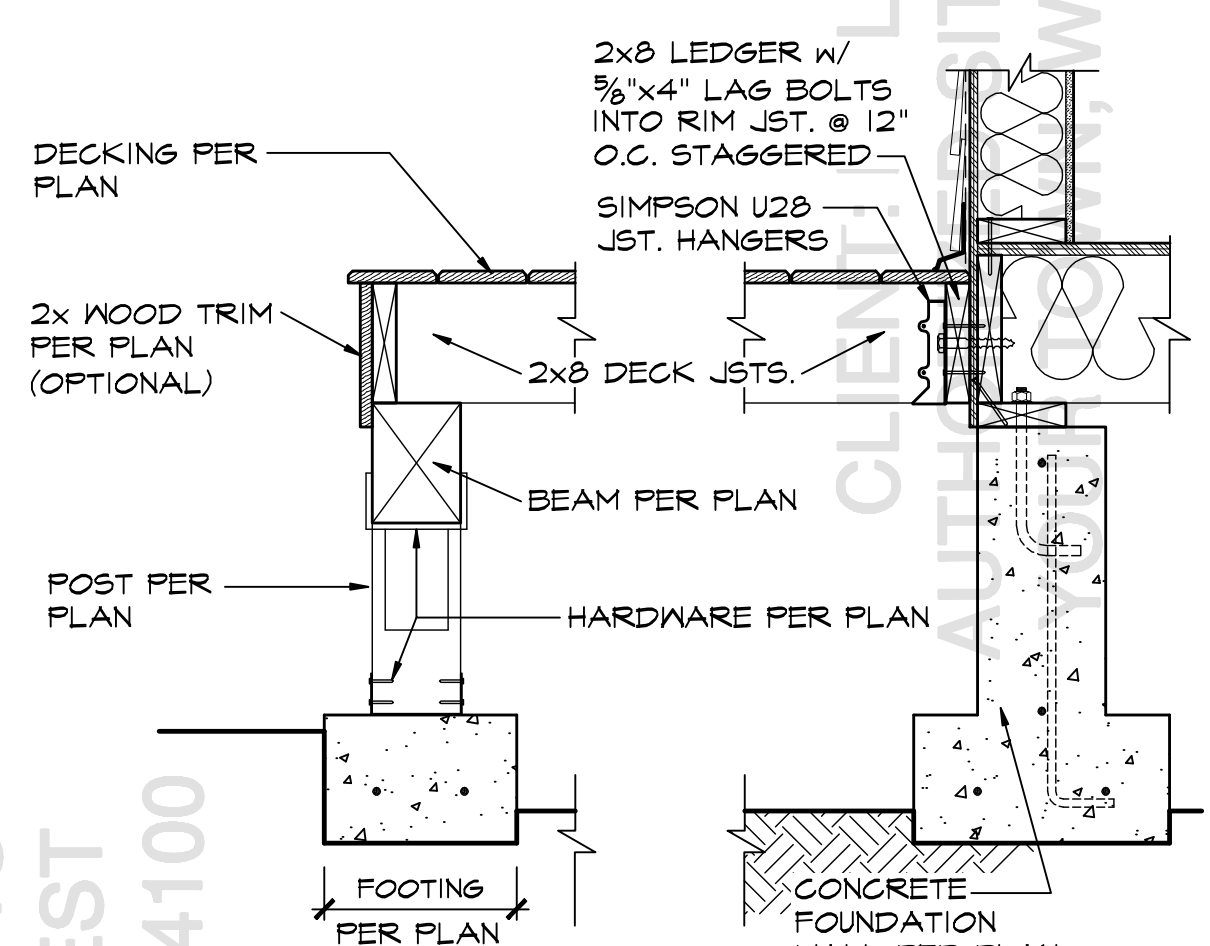

7 DECK
SCALE: 1" = 1'-0"

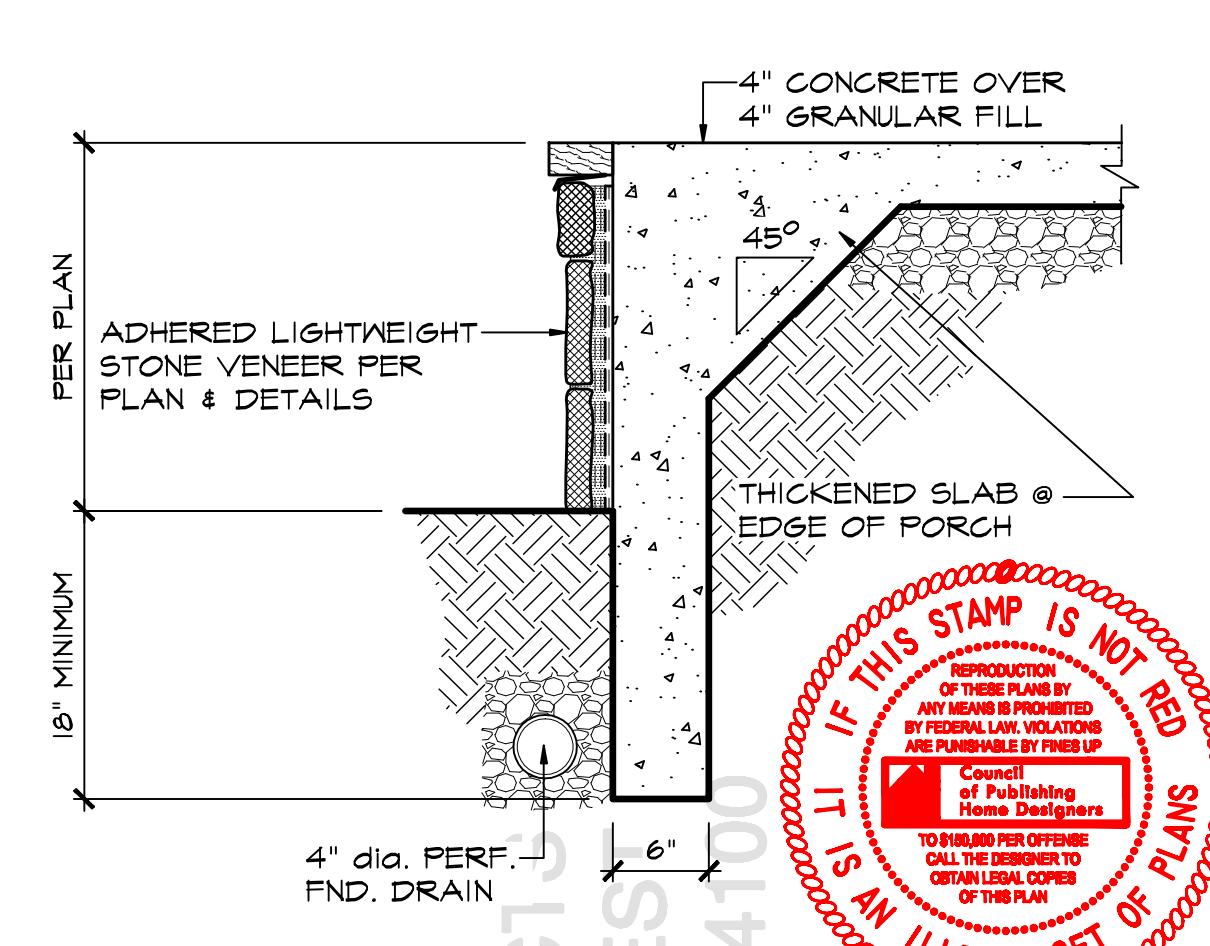

8 PORCH
SCALE: 1" = 1'-0"

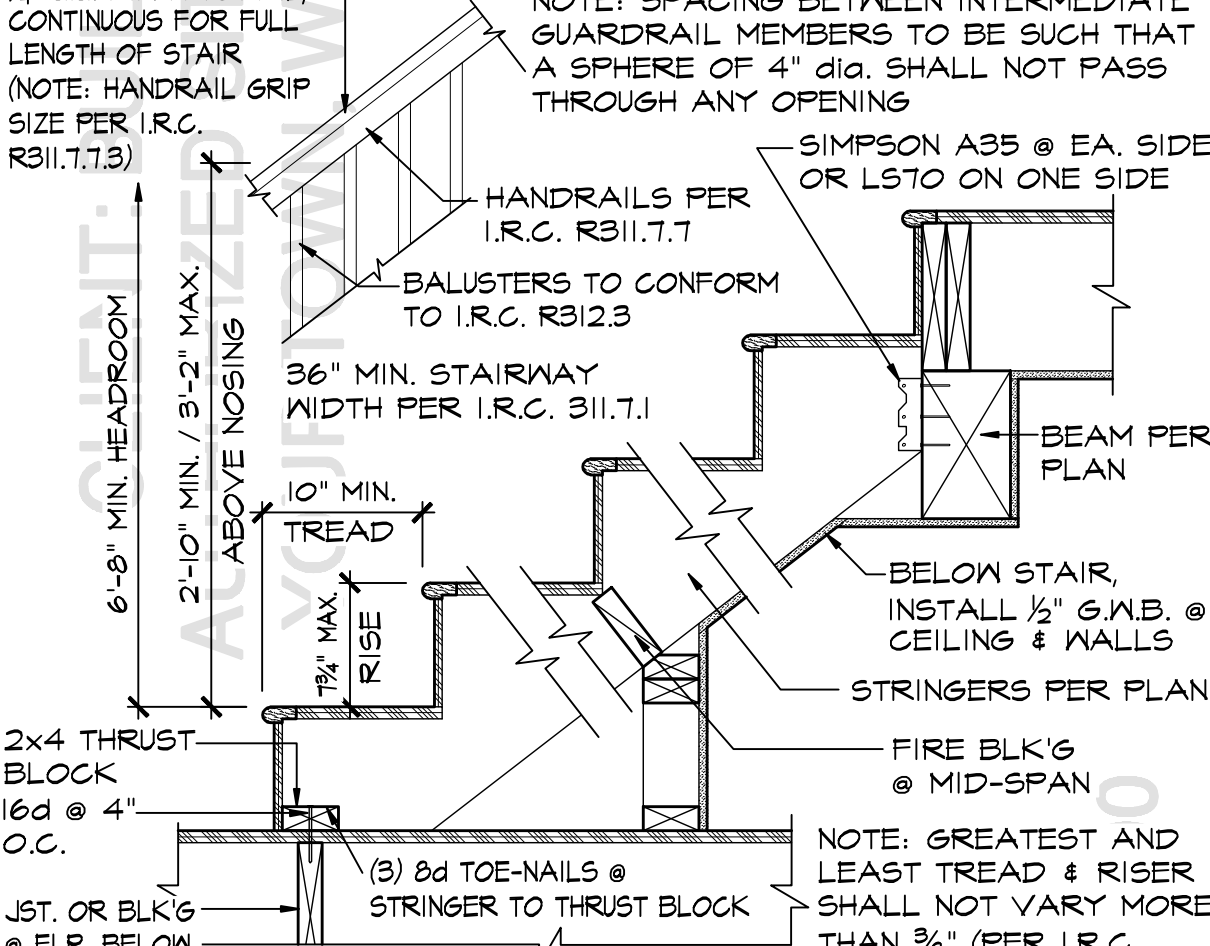

9 INTERIOR STAIR
SCALE: 1" = 1'-0"

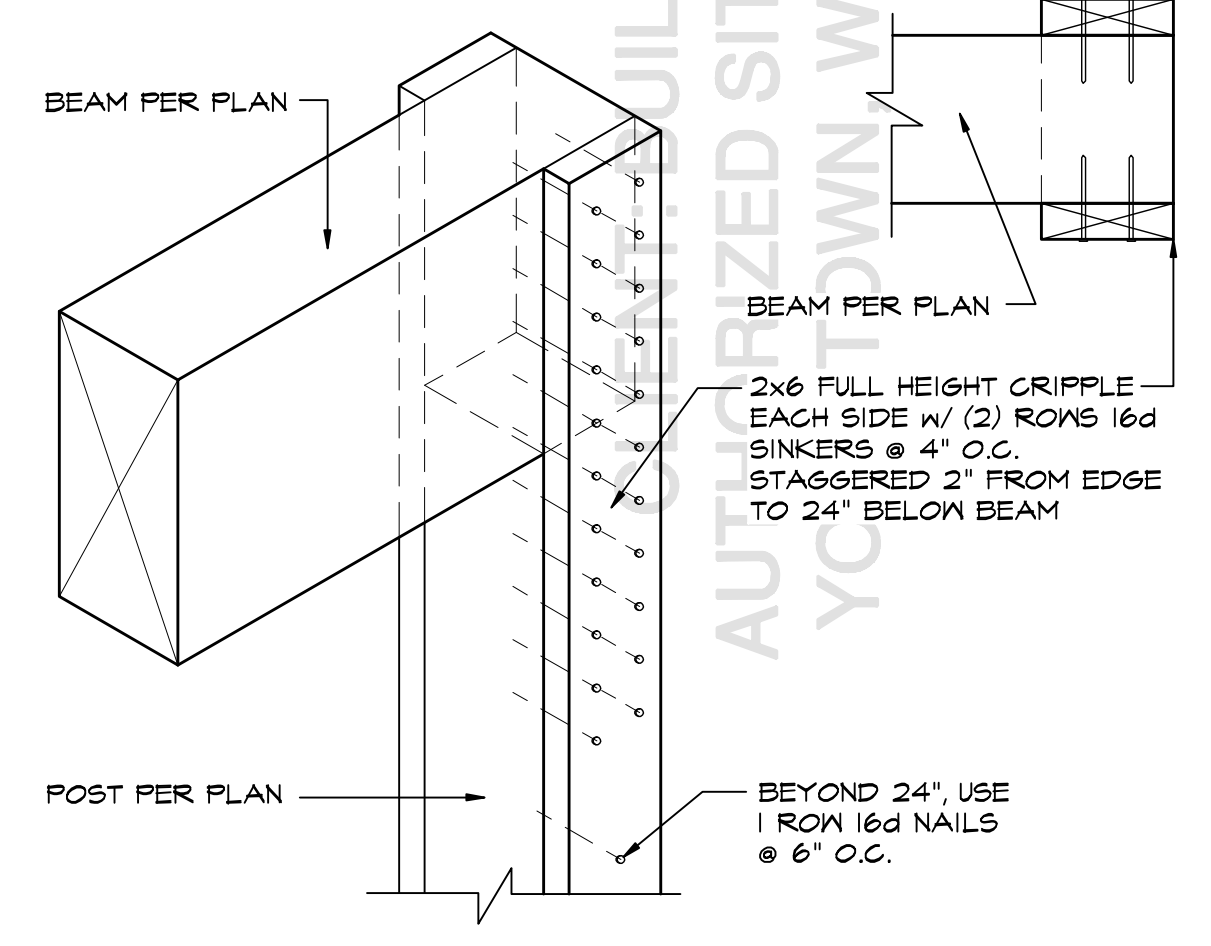

10 BEAM DETAIL
SCALE: 1 1/2" = 1'-0"

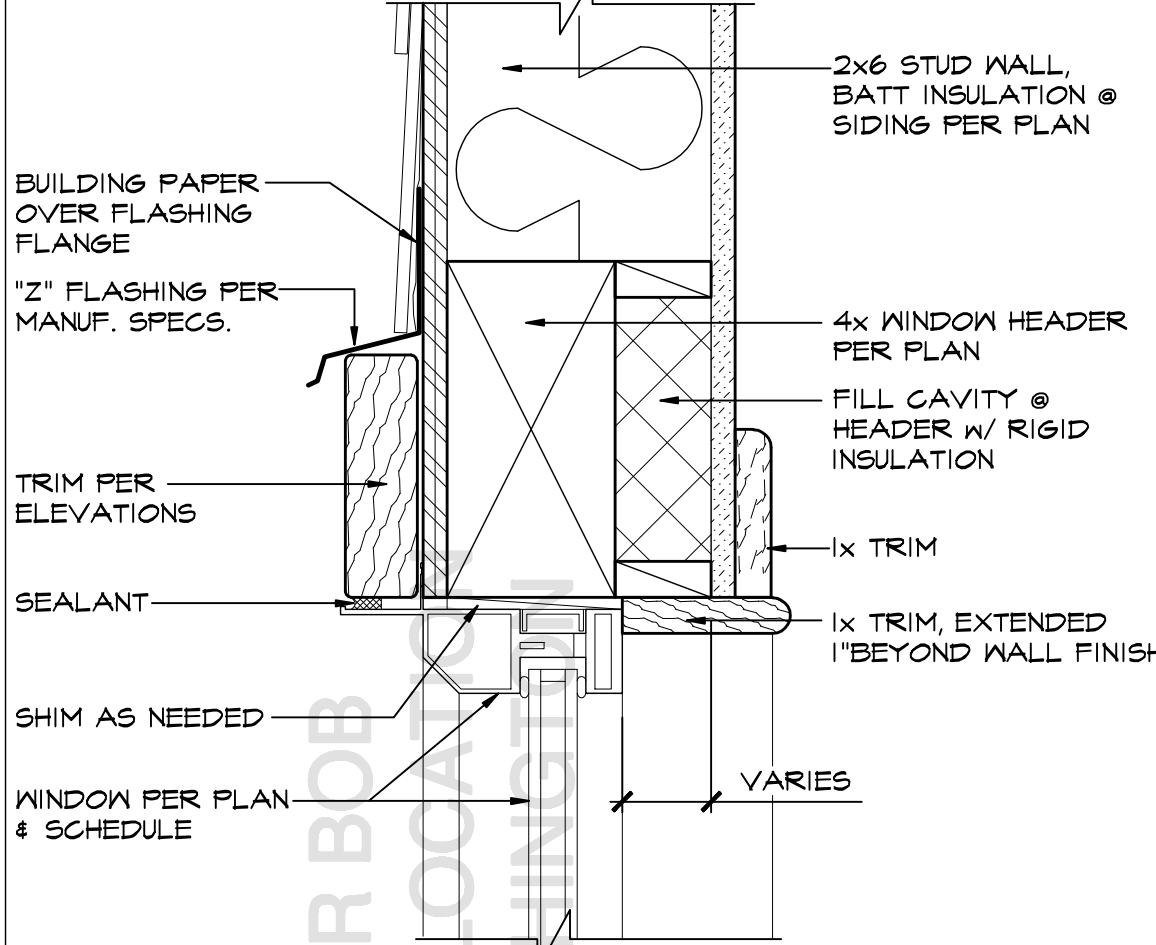

11 TYPICAL WINDOW HEADER
SCALE: 3" = 1'-0"

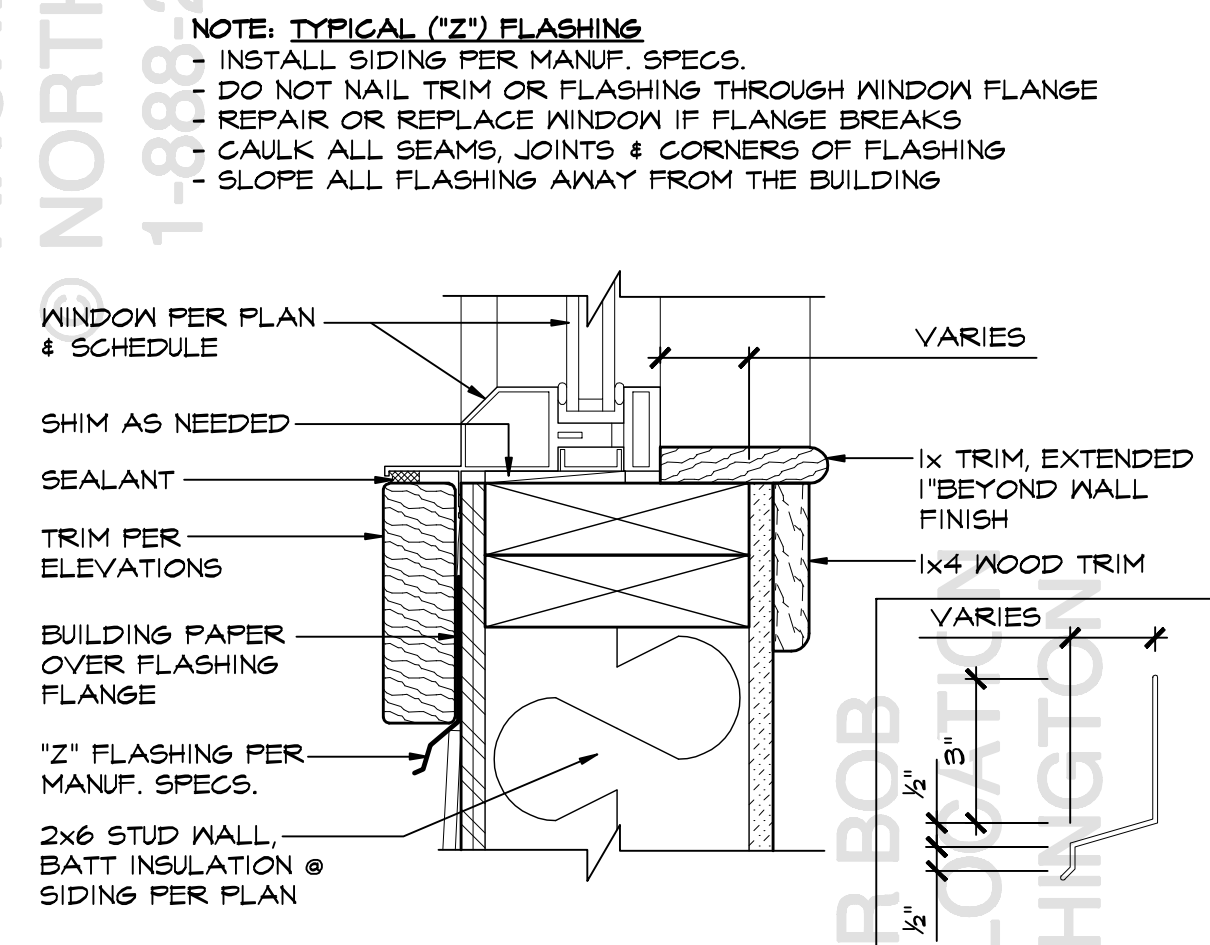

12 TYPICAL WINDOW SILL
SCALE: 3" = 1'-0"

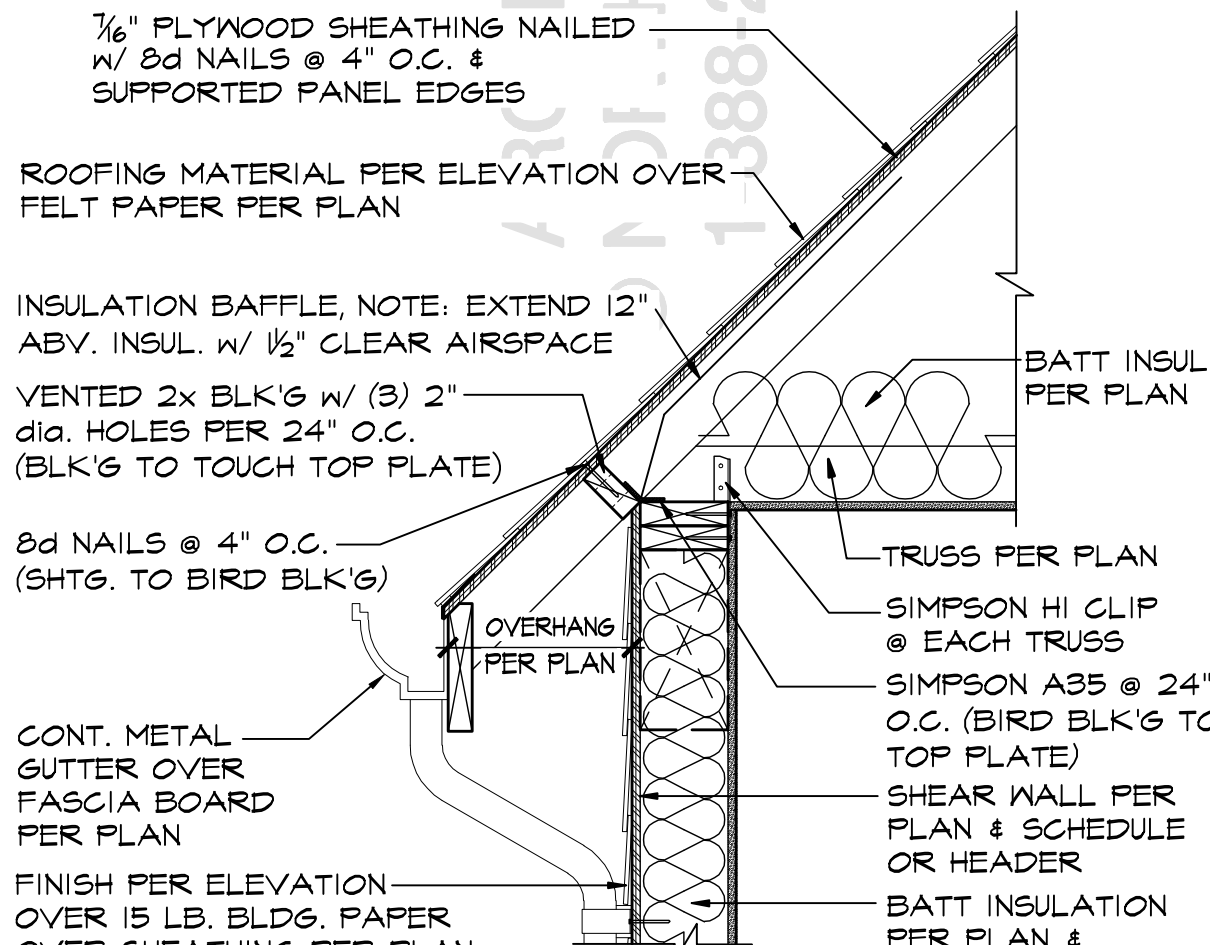

13 FLAT CEILING @ EAVE
SCALE: 1" = 1'-0"

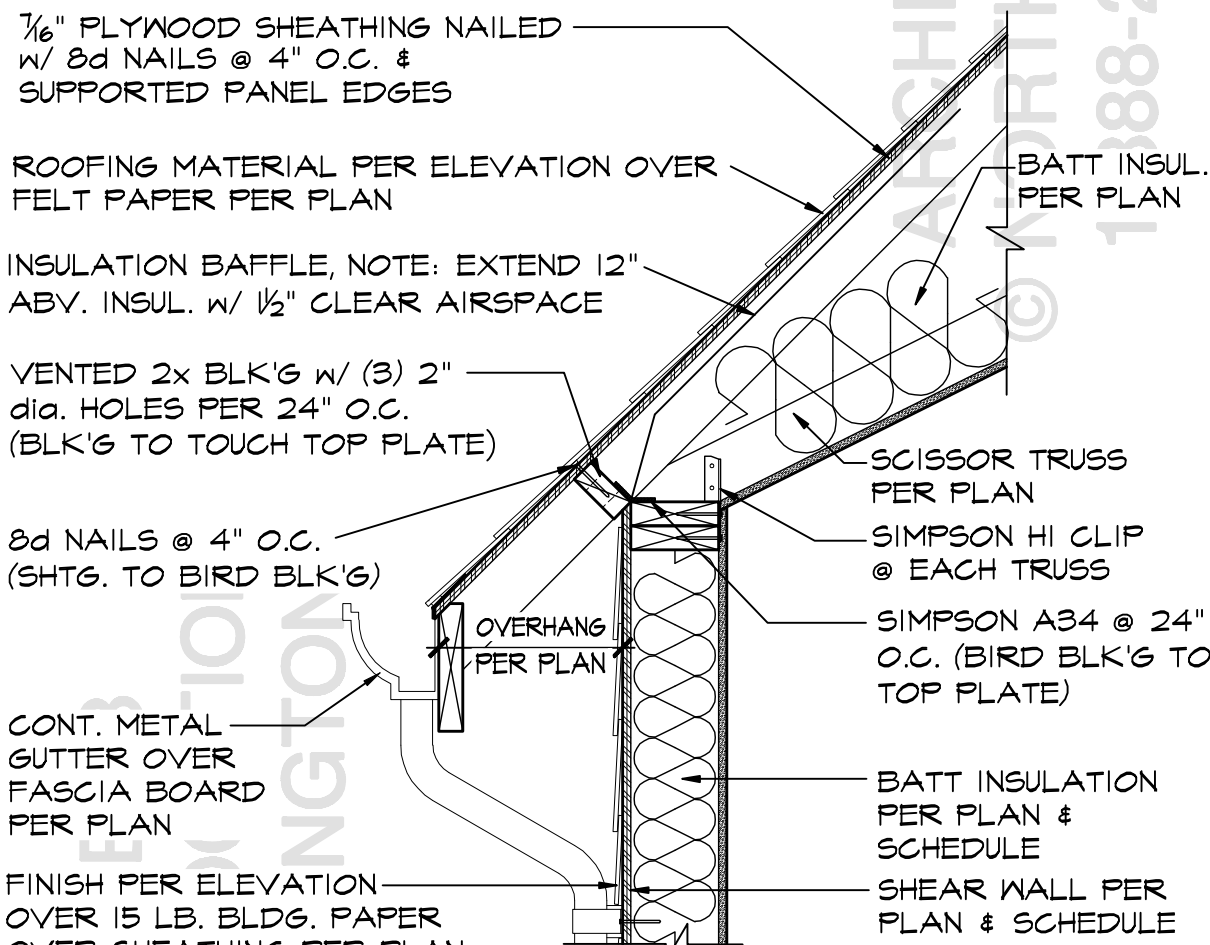

14 SLOPED CEILING @ EAVE
SCALE: 1" = 1'-0"

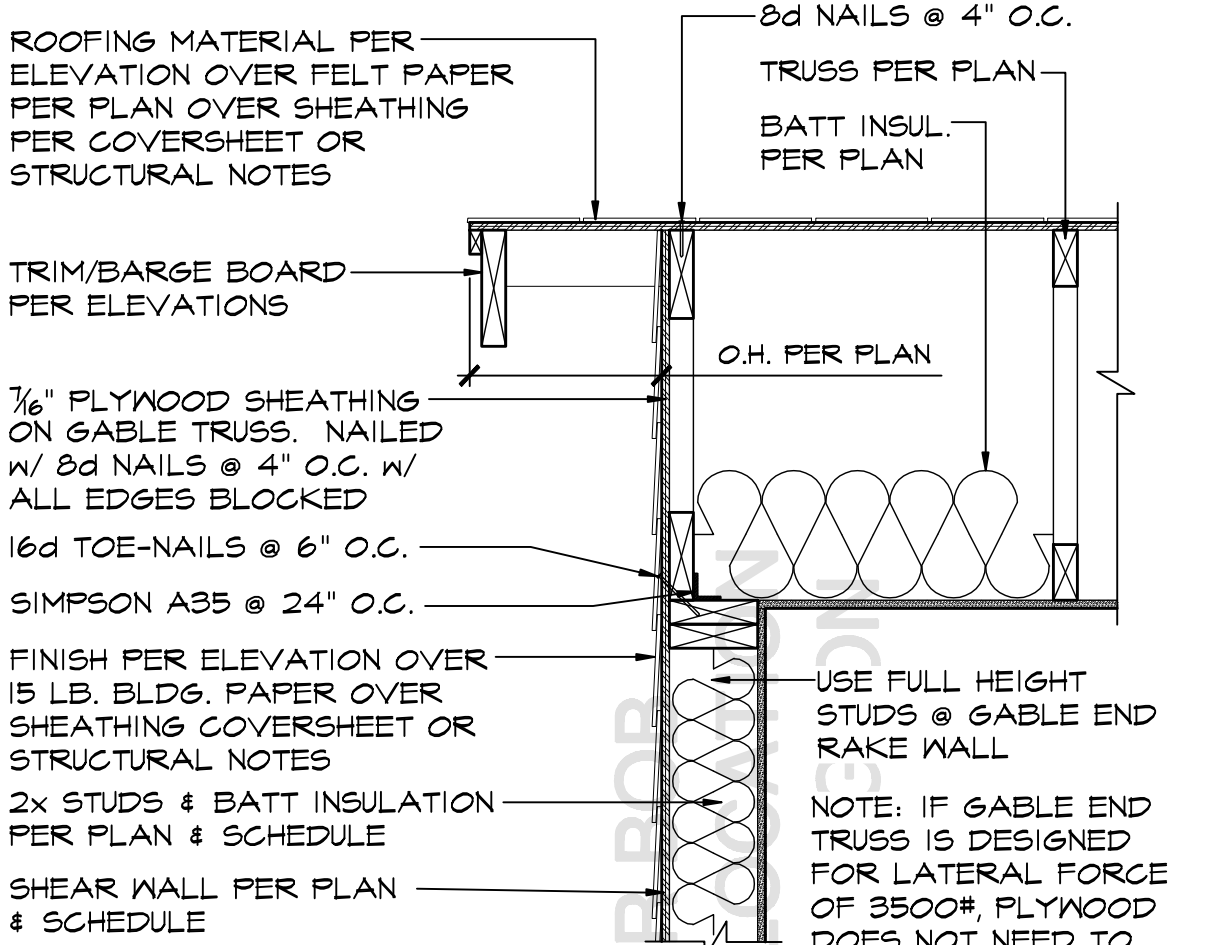

15 GABLE END DETAIL
SCALE: 1" = 1'-0"

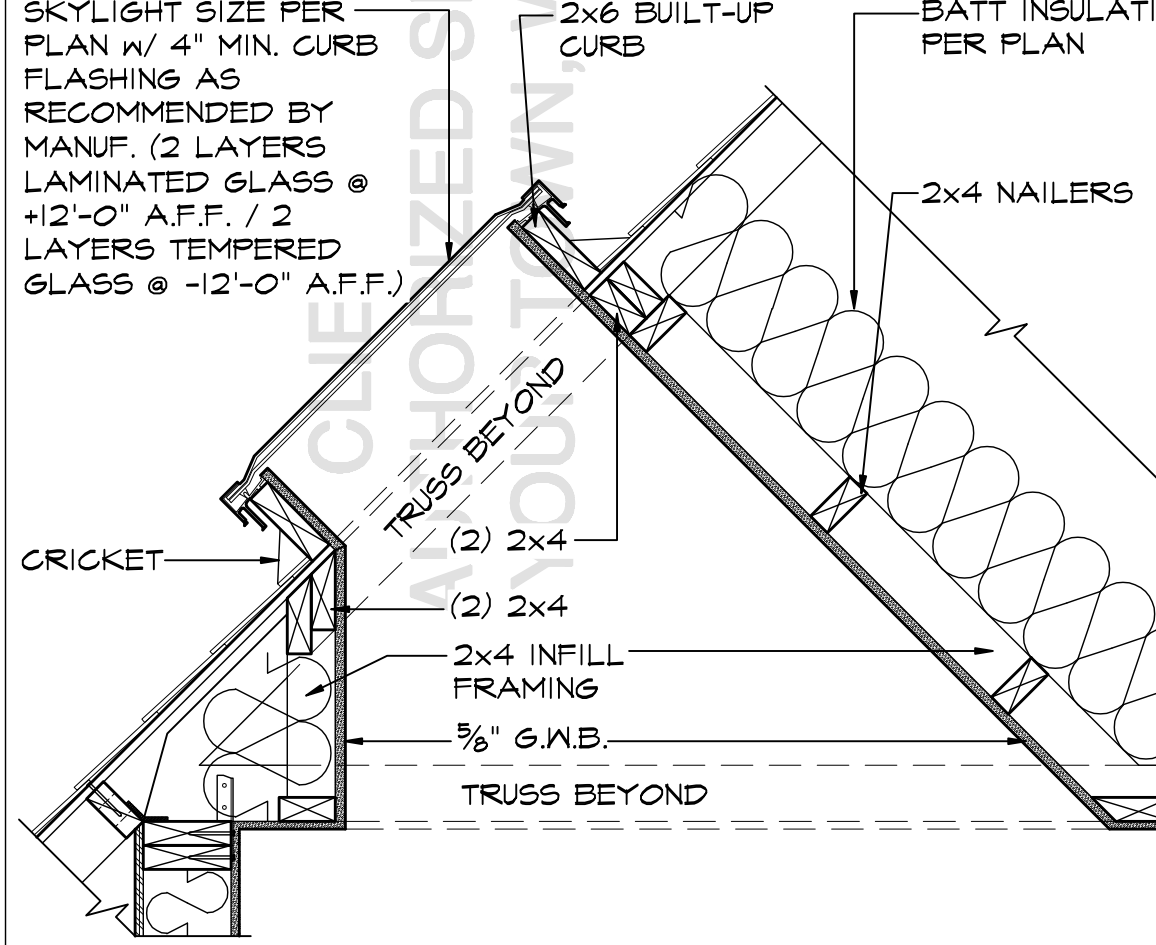

16 SKYLIGHT
SCALE: 1" = 1'-0"

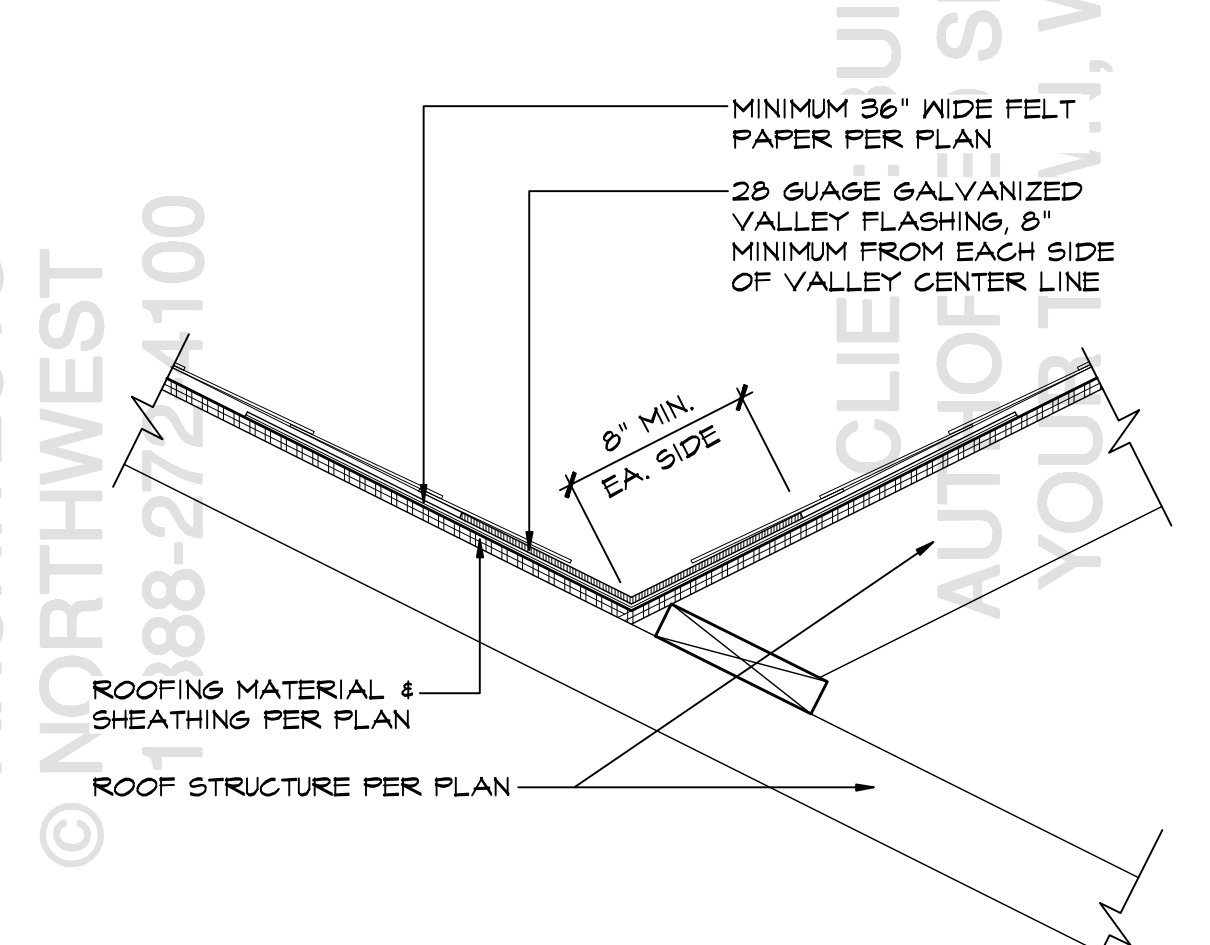

17 ROOF VALLEY FLASHING
SCALE: 1 1/2" = 1'-0"

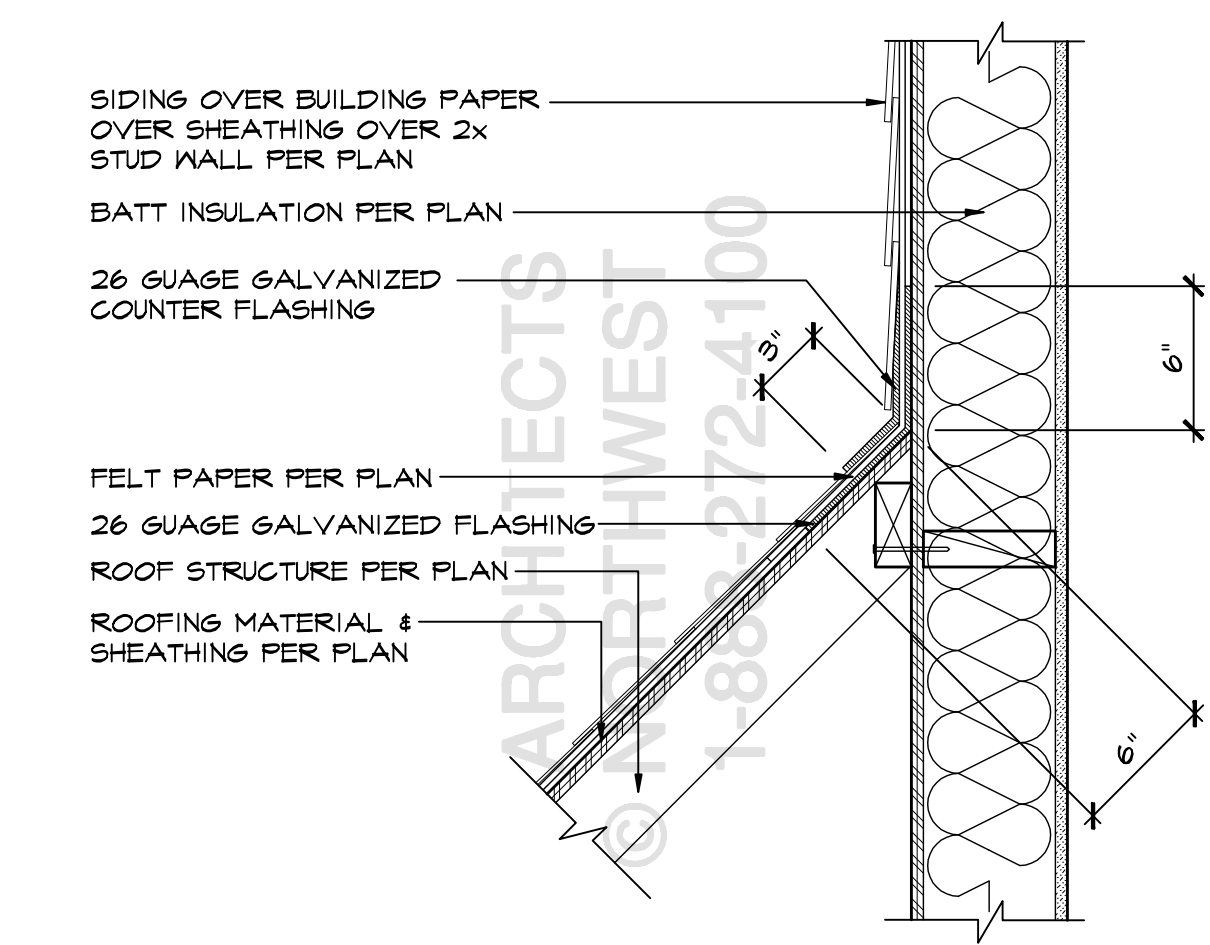

18 ROOF TO WALL FLASHING
SCALE: 1 1/2" = 1'-0"

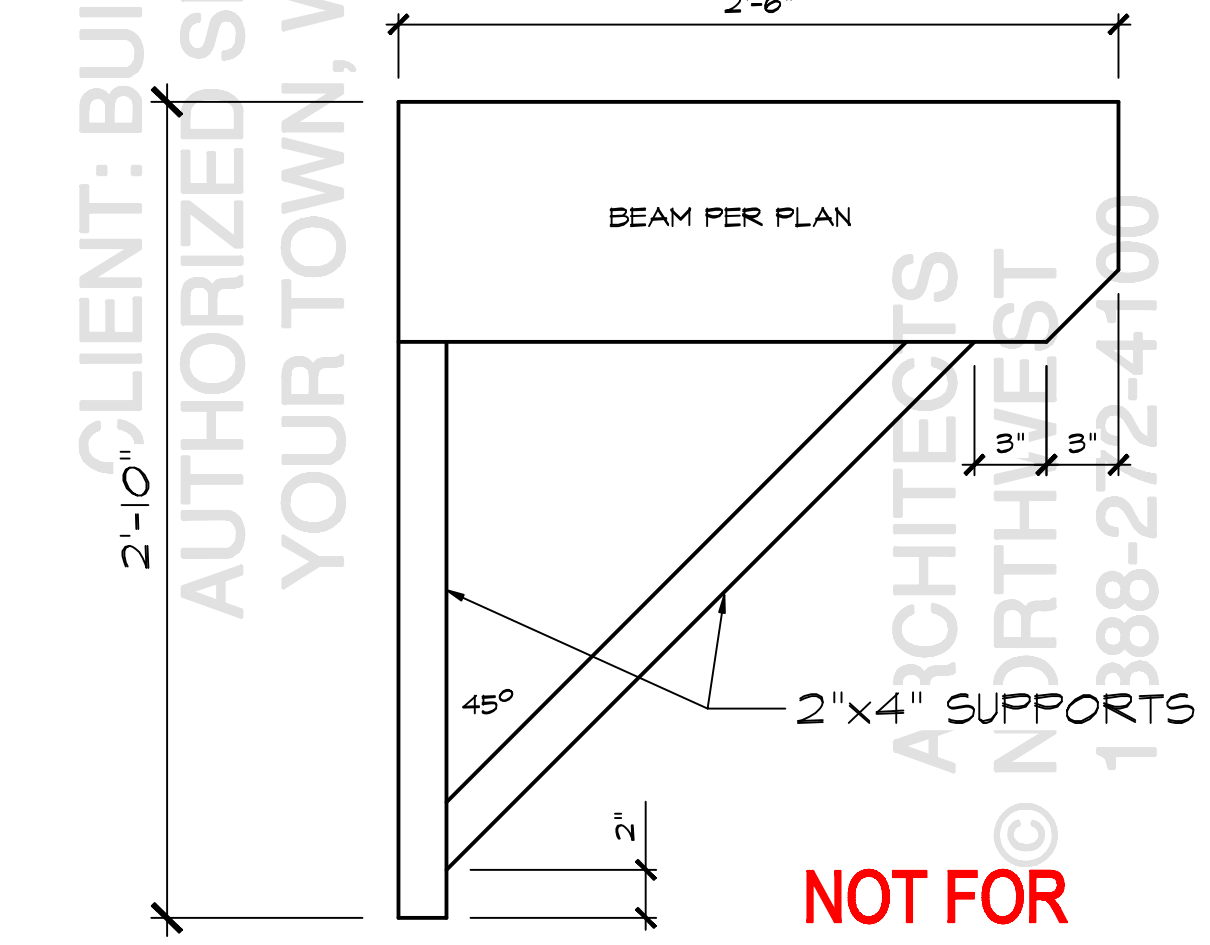

19 BRACKET DETAIL
SCALE: 1" = 1'-0"

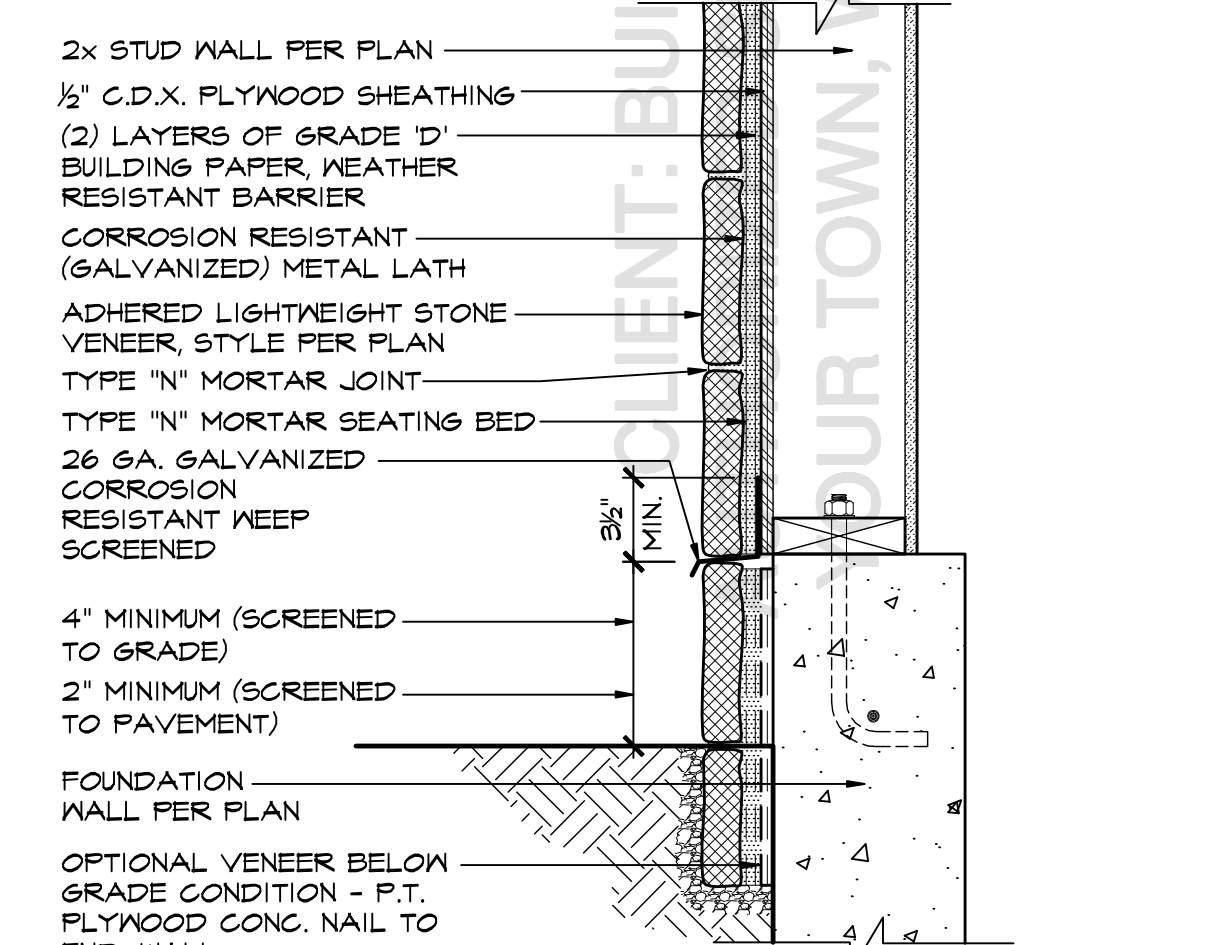

20 ADHERED LIGHTWEIGHT VENEER
SCALE: 1 1/2" = 1'-0"

NOT FOR CONSTRUCTION

NOT FOR CONSTRUCTION

ARCHITECTS NORTHWEST

BUILDER BOB
ARCHITECTS NORTHWEST
 18915-142nd AVENUE NE SUITE 100 WOODINVILLE, WA 98072
 OFFICE: (425) 485-9900 FAX: (425) 487-6585
 WWW.ARCHITECTSNW.COM

DESIGNED BY: TJC DATE: 1/19/16
 DRAWN BY: SMD DATE: 4/20/16
 PROJECT MANAGER: TROY CLYMER
 REVISED BY: JRA DATE: 9/1/11

LATERAL BY: XXXX DATE: XXXX
 LATERAL JOB NUMBER: XXX-XXXX

A3
A10
 ANW WOODVILLE OFFICE JOB NUMBER: W10XXX